

ETSI EN 300 182-1 V1.3.6 (1999-09)

European Standard (Telecommunications series)

**Integrated Services Digital Network (ISDN);
Advice of Charge (AOC) supplementary service;
Digital Subscriber Signalling System No. one (DSS1) protocol;
Part 1: Protocol specification**



Reference

REN/SPS-05129-1 (10090j40.PDF)

Keywords

ISDN, AOC, DSS1, supplementary service,
protocol

ETSI

Postal address

F-06921 Sophia Antipolis Cedex - FRANCE

Office address

650 Route des Lucioles - Sophia Antipolis
Valbonne - FRANCE
Tel.: +33 4 92 94 42 00 Fax: +33 4 93 65 47 16
Siret N° 348 623 562 00017 - NAF 742 C
Association à but non lucratif enregistrée à la
Sous-Préfecture de Grasse (06) N° 7803/88

Internet

secretariat@etsi.fr
Individual copies of this ETSI deliverable
can be downloaded from
<http://www.etsi.org>
If you find errors in the present document, send your
comment to: editor@etsi.fr

Copyright Notification

No part may be reproduced except as authorized by written permission.
The copyright and the foregoing restriction extend to reproduction in all media.

© European Telecommunications Standards Institute 1999.
All rights reserved.

Contents

Intellectual Property Rights	5
Foreword	5
1 Scope.....	7
2 References	7
3 Definitions and abbreviations.....	8
3.1 Definitions.....	8
3.2 Abbreviations.....	9
4 Description.....	10
4.1 General description.....	10
4.2 Charging information at call set-up time (AOC-S)	10
4.3 Charging information during the call (AOC-D)	10
4.4 Charging information at the end of the call (AOC-E)	10
5 Operational requirements.....	10
5.1 Provision and withdrawal	10
5.2 Requirements on the originating network side.....	11
5.3 Requirements on the destination network side.....	11
6 Coding requirements	11
6.1 General.....	11
6.2 Coding of the Facility information element components.....	11
7 State definitions.....	15
8 Signalling procedures at the coincident S and T reference point.....	15
8.1 Activation, deactivation and registration.....	15
8.1.1 Normal operation.....	15
8.1.2 Exceptional procedures	16
8.2 Invocation and operation	17
8.2.1 Transfer of charging information in the call establishment phase.....	17
8.2.1.1 Normal operation	17
8.2.1.2 Exceptional procedures.....	18
8.2.2 Transfer of charging information in the Active state	18
8.2.2.1 Normal operation.....	18
8.2.2.2 Exceptional procedures.....	19
8.2.3 Transfer of charging information in the call clearing phase	19
8.2.3.1 Normal operation.....	19
8.2.3.2 Exceptional procedures.....	20
8.2.4 Transfer of charging information independent of a bearer at the user-network interface	21
8.2.4.1 Normal operation.....	21
8.2.4.2 Exceptional procedures.....	22

9	Procedures for interworking with private ISDNs.....	22
10	Interactions with other networks.....	22
11	Interactions with other supplementary services.....	22
12	Parameter values (timers).....	22
13	Dynamic description (SDL diagrams).....	23
Annex A (informative):	Signalling flows.....	34
Annex B (informative):	Changes with respect to the previous version of EN 300 182-1 (V1.2.4).....	39
History		40

Intellectual Property Rights

IPRs essential or potentially essential to the present document may have been declared to ETSI. The information pertaining to these essential IPRs, if any, is publicly available for **ETSI members and non-members**, and can be found in SR 000 314: "*Intellectual Property Rights (IPRs); Essential, or potentially Essential, IPRs notified to ETSI in respect of ETSI standards*", which is available from the ETSI Secretariat. Latest updates are available on the ETSI Web server (<http://www.etsi.org/ipr>).

Pursuant to the ETSI IPR Policy, no investigation, including IPR searches, has been carried out by ETSI. No guarantee can be given as to the existence of other IPRs not referenced in SR 000 314 (or the updates on the ETSI Web server) which are, or may be, or may become, essential to the present document.

Foreword

This European Standard (Telecommunications series) has been produced by ETSI Technical Committee Services and Protocols for Advanced Networks (SPAN).

The present document is part 1 of a multi-part standard covering the Digital Subscriber Signalling System No. one (DSS1) protocol specification for the Integrated Services Digital Network (ISDN) Advice of Charge (AOC) supplementary service, as described below:

- Part 1: "Protocol specification";**
- Part 2: "Protocol Implementation Conformance Statement (PICS) proforma specification";
- Part 3: "Test Suite Structure and Test Purposes (TSS&TP) specification for the user";
- Part 4: "Abstract Test Suite (ATS) and partial Protocol Implementation eXtra Information for Testing (PIXIT) proforma specification for the user";
- Part 5: "Test Suite Structure and Test Purposes (TSS&TP) specification for the network";
- Part 6: "Abstract Test Suite (ATS) and partial Protocol Implementation eXtra Information for Testing (PIXIT) proforma specification for the network".

In accordance with CCITT Recommendation I.130 [2], the following three level structure is used to describe the supplementary telecommunications services as provided by European public telecommunications operators under the pan-European Integrated Services Digital Network (ISDN):

- Stage 1: is an overall service description, from the user's standpoint;
- Stage 2: identifies the functional capabilities and information flows needed to support the service described in stage 1; and
- Stage 3: defines the signalling system protocols and switching functions needed to implement the service described in stage 1.

The present document details the stage 3 aspects (signalling system protocols and switching functions) needed to support the Advice of Charge (AOC) supplementary service. The stage 1 and stage 2 aspects are detailed in ETS 300 178 [6] to ETS 300 180 [8] and ETS 300 181 [14], respectively.

National transposition dates

Date of adoption of this EN:	10 September 1999
Date of latest announcement of this EN (doa):	31 December 1999
Date of latest publication of new National Standard or endorsement of this EN (dop/e):	30 June 2000
Date of withdrawal of any conflicting National Standard (dow):	30 June 2000

1 Scope

This first part of EN 300 182 specifies the stage three of the Advice of Charge (AOC) supplementary service for the pan-European Integrated Services Digital Network (ISDN) as provided by European public telecommunications operators at the T reference point or coincident S and T reference point (as defined in CCITT Recommendation I.411 [1]) by means of the Digital Subscriber Signalling System No. one (DSS1). Stage three identifies the protocol procedures and switching functions needed to support a telecommunications service (see CCITT Recommendation I.130 [2]).

In addition, the present document specifies the protocol requirements at the T reference point where the service is provided to the user via a private ISDN.

The present document does not specify the additional protocol requirements where the service is provided to the user via a telecommunications network that is not an ISDN.

Three AOC supplementary services exist:

a) Charging information at call set-up time (AOC-S)

The AOC-S supplementary service enables a user to receive information about the charging rates at call set-up time and also to receive further information during the call if there is a change of charging rates.

b) Charging information during the call (AOC-D)

The AOC-D supplementary service enables a user to receive information on the recorded charges for a call during the active phase of the call.

c) Charging information at the end of the call (AOC-E)

The AOC-E supplementary service enables a user to receive information on the recorded charges for a call when the call is terminated.

The AOC supplementary service is applicable to all circuit-switched telecommunication services.

Further parts of the present document specify the method of testing required to identify conformance to the present document.

The present document is applicable to equipment, supporting the AOC supplementary service, to be attached at either side of a T reference point or coincident S and T reference point when used as an access to the public ISDN.

2 References

The following documents contain provisions which, through reference in this text, constitute provisions of the present document.

- References are either specific (identified by date of publication, edition number, version number, etc.) or non-specific.
- For a specific reference, subsequent revisions do not apply.
- For a non-specific reference, the latest version applies.
- A non-specific reference to an ETS shall also be taken to refer to later versions published as an EN with the same number.

[1] CCITT Recommendation I.411 (1988): "ISDN user-network interfaces - Reference configurations".

[2] CCITT Recommendation I.130 (1988): "Method for the characterization of telecommunication services supported by an ISDN and network capabilities of an ISDN".

[3] ITU-T Recommendation I.112: "Vocabulary of terms for ISDNs".

- [4] ITU-T Recommendation I.210: "Principles of telecommunication services supported by an ISDN and the means to describe them".
- [5] EN 300 403-1 (V1.3): "Integrated Services Digital Network (ISDN); Digital Subscriber Signalling System No. one (DSS1) protocol; Signalling network layer for circuit-mode basic call control; Part 1: Protocol specification [ITU-T Recommendation Q.931 (1993), modified]".
- [6] ETS 300 178: "Integrated Services Digital Network (ISDN); Advice of Charge: charging information at call set-up time (AOC-S) supplementary service; Service description".
- [7] ETS 300 179: "Integrated Services Digital Network (ISDN); Advice of Charge: charging information during the call (AOC-D) supplementary service; Service description".
- [8] ETS 300 180: "Integrated Services Digital Network (ISDN); Advice of Charge: charging information at the end of the call (AOC-E); Service description".
- [9] CCITT Recommendation X.208 (1988): "Specification of Abstract Syntax Notation One (ASN.1)".
- [10] CCITT Recommendation X.219 (1988): "Remote Operations: Model, notation and service definition".
- [11] EN 300 196-1: "Integrated Services Digital Network (ISDN); Generic functional protocol for the support of supplementary services; Digital Subscriber Signalling System No. one (DSS1) protocol; Part 1: Protocol specification".
- [12] EN 300 195-1: "Integrated Services Digital Network (ISDN); Supplementary service interactions; Digital Subscriber Signalling System No. one (DSS1) protocol; Part 1: Protocol specification".
- [13] ITU-T Recommendation Z.100: "CCITT Specification and description language (SDL)".
- [14] ETS 300 181: "Integrated Services Digital Network (ISDN); Advice of Charge (AOC) supplementary service; Functional capabilities and information flows".

3 Definitions and abbreviations

3.1 Definitions

For the purposes of the present document, the following terms and definitions apply:

activation: implies either a user request for AOC supplementary service(s) or a network performed activation of the subscribed AOC supplementary service(s) whenever the served user makes an outgoing call.

NOTE 1: The stage 1 description, as specified in ETS 300 178 [6], ETS 300 179 [7] and ETS 300 180 [8], defines activation as being performed at the time of subscription.

basic communication: this charged item indicates the rate to be applied for the connection to the called user.

billing identification: elements for billing identification inform the served user that the associated charges have been incurred due to the indicated situation (e.g. a call that has been forwarded at the served user's access).

call attempt: this charged item indicates the cost applied for a call which has been sent to the called user, but the called user has not yet answered the call.

call control message: message as defined in EN 300 403-1 [5], subclause 3.1, which on sending or receipt causes a change of the call state at either the network or the user.

call setup: this charged item indicates the cost applied for the connection to the called user when the called user answers the call.

charging information: information sent to a user in an invoke component or a return result component showing charging-related information (i.e. either charging rate information, special charging rates, or the recorded charges for the call).

continuous: see subclause A.2.3.1 of ETS 300 178 [6].

flat rate: this specific rate indicates a fixed currency value per event.

Integrated Services Digital Network (ISDN): see CCITT Recommendation I.112 [3], § 2.3, definition 308.

invocation: implies the sending of charging information from the network to the served user.

NOTE 2: The stage 1 description, as specified in ETS 300 178 [6], ETS 300 179 [7] and ETS 300 180 [8], defines invocation as either a user request for an AOC supplementary service or as the network invocation for all calls.

invoke component: see EN 300 196-1 [11], subclause 8.2.2.1.

network: DSS1 protocol entity at the network side of the user-network interface.

operation of supplementary services: this charged item indicates the cost applied for the operation of requested supplementary services.

recorded charges: this information indicates the number of charging units or currency units incurred for a call.

return error component: see EN 300 196-1 [11], subclause 8.2.2.3.

return result component: see EN 300 196-1 [11], subclause 8.2.2.2.

served user: user of a particular ISDN number, who is requesting that charging information should be provided (for all calls or on request).

service: telecommunications service: see CCITT Recommendation I.112 [3], § 2.2, definition 201.

special charging arrangement: this charged item indicates that a special charging arrangement exists for calculating the cost of the call.

NOTE 3: The use of this charged item is outside the scope of the standard. It is a matter for the network operator and the user to which it is sent.

special charging code: this specific code indicates a rate which can identify a charging algorithm that can be used as a basis for determining the cost of a call.

step function: see subclause A.2.3.1 of ETS 300 178 [6].

supplementary service: see CCITT Recommendation I.210 [4], § 2.4.

user: DSS1 protocol entity at the user side of the user-network interface.

user-to-user information transfer: this charged item indicates the rate to be applied to the transfer of user-to-user information.

3.2 Abbreviations

For the purposes of the present document, the following abbreviations apply:

AOC	Advice of Charge
AOC-D	AOC During the call
AOC-E	AOC at the End of the call
AOC-S	AOC at call Set-up time
ASN.1	Abstract Syntax Notation One
ATS	Abstract Test Suite
DSS1	Digital Subscriber Signalling System No. one
ISDN	Integrated Services Digital Network
PICS	Protocol Implementation Conformance Statement
TSS&TP	Test Suite Structure and Test Purposes

4 Description

4.1 General description

Depending on subscription by the served user, charging information for any of the three supplementary services may be provided either:

- for all calls; or
- for any call, after a user request to provide charging information.

The charging information given shall relate to the charges incurred on the network to which the user is attached.

Charging information for applications using higher layer protocols which are not defined as teleservices, shall be based on the bearer services specified.

4.2 Charging information at call set-up time (AOC-S)

When the AOC-S supplementary service is activated, the network shall provide the user with information about the charging rates at call establishment. In addition, the network shall inform the served user if a change in charging rates takes place during the call.

The network shall provide the charging information during call establishment or at the latest at call connection. When there is a change in the charging rate during the call, the network shall send information about the new charging rate to the served user.

4.3 Charging information during the call (AOC-D)

When the AOC-D supplementary service is activated, the network shall provide the user with charging information for a call during the active phase of a call. The network shall provide the charging information and transfer it to the served user in an appropriate message. The supplied charging information shall be provided as a cumulative charge incurred so far for the call (i.e. charges recorded from the start of the call and until the moment the charging information is sent to the served user).

When the call is released, the network shall send the recorded charges for the call to the served user in one of the call control messages clearing the call.

If the network has determined that the call is free of charge, then the network shall send a free-of-charge indication in the first subsequent message sent to the served user. The network shall not send any further charging information during the call. When the call is released, the network shall send the charged amount (zero) in a call control message clearing the call.

4.4 Charging information at the end of the call (AOC-E)

When the AOC-E supplementary service is activated, the network shall provide the served user with charging information indicating the recorded charges for a call when the call is released. The network shall send the charging information to the served user in one of the call control messages clearing the call.

5 Operational requirements

5.1 Provision and withdrawal

These supplementary services shall be provided separately by arrangement with the service provider or be generally available. Withdrawal of the service shall be made at subscriber request or for administrative reasons.

The following subscription options exist for each of the three AOC supplementary services, as defined in table 1.

Table 1: Advice of charge subscription options

Subscription options	Value
Provision of service	1. For all calls; or
	2. On request on a per call basis.

5.2 Requirements on the originating network side

For the purpose of the present document, the served user of the AOC supplementary service is connected to the originating network.

The originating network shall make available the type of charging information that is indicated, related to a certain call.

The originating network shall assemble the appropriate charging information, according to the service requirements, and send it to the user.

NOTE: The charging information may either be generated at the originating network, or generated elsewhere and sent to the originating network, in due time for the information to be provided to the user according to the procedures of the present document.

The network shall only include a charged item if the charged item contains information concerning the charges applied to that call.

The network shall only use those charged items which are appropriate to that network charging mechanism. Thus, in some networks, the network may, but need not, send some of these items, or combinations of items. Different networks could give information about the same call in different ways.

If the served user suspends a call, then, as a network option, the originating network shall retain the charging information for the suspended call as long as the network retains the call identity of the suspended call of the served user.

5.3 Requirements on the destination network side

None identified.

6 Coding requirements

6.1 General

The charging information that the network shall convey to the served user may consist of a number of information units. The information to be transferred is specified in clause 5 of the stage 1 service descriptions ETS 300 178 [6], ETS 300 179 [7], and ETS 300 180 [8].

6.2 Coding of the Facility information element components

Table 2 shows the definition of the operations and errors required for the AOC supplementary service using Abstract Syntax Notation one (ASN.1) as defined in CCITT Recommendation X.208 [9] and using the OPERATION and ERROR macro as defined in CCITT Recommendation X.219 [10], figure 4/X.219.

The formal definition of the component types to encode these operations and errors is provided in EN 300 196-1 [11], annex D, clause D.1.

The inclusion of components in Facility information elements is defined in EN 300 196-1 [11], subclause 11.1.

Table 2: Definition of operations and errors for the AOC supplementary services

```

Advice-of-Charge-Operations {ccitt identified-organization etsi (0) 182 operations-and-errors
(1)}

DEFINITIONS IMPLICIT TAGS ::=

BEGIN

EXPORTS      ChargingRequest, AOCSCurrency, AOCSSpecialArr,
              AOCDCurrency, AOCDChargingUnit, AOCECurrency, AOCEChargingUnit,
              NoChargingInfoAvailable, ChargingAssociation;

IMPORTS      OPERATION, ERROR
              FROM Remote-Operation-Notation
               {joint-iso-ccitt remote-operations (4) notation (0)}
              notSubscribed, notAvailable, notImplemented, invalidCallState
              FROM General-Errors
               {ccitt identified-organization etsi (0) 196 general-errors (2)}
              PartyNumber
              FROM Addressing-Data-Elements
               {ccitt identified-organization etsi (0) 196 addressing-data-elements (6)};

ChargingRequest ::= OPERATION
  ARGUMENT ChargingCase
  RESULT CHOICE {
    AOCSCurrencyInfoList,
    AOCSSpecialArrInfo,
    chargingInfoFollows NULL}
  ERRORS {notSubscribed, notAvailable, notImplemented,
    invalidCallState, NoChargingInfoAvailable}

AOCSCurrency ::= OPERATION          -- AOC-S given in currency units
  ARGUMENT CHOICE {
    chargeNotAvailable NULL,
    AOCSCurrencyInfoList }

AOCSSpecialArr ::= OPERATION       -- AOC-S for special charging arrangement
  ARGUMENT CHOICE {
    chargeNotAvailable NULL,
    AOCSSpecialArrInfo }

AOCDCurrency ::= OPERATION         -- AOC-D given in currency units
  ARGUMENT CHOICE {
    chargeNotAvailable NULL,
    AOCDCurrencyInfo }

AOCDChargingUnit ::= OPERATION     -- AOC-D given in charging units
  ARGUMENT CHOICE {
    chargeNotAvailable NULL,
    AOCDChargingUnitInfo }

AOCECurrency ::= OPERATION         -- AOC-E given in currency units
  ARGUMENT CHOICE {
    chargeNotAvailable NULL,
    AOCECurrencyInfo }

AOCEChargingUnit ::= OPERATION     -- AOC-E given in charging units
  ARGUMENT CHOICE {
    chargeNotAvailable NULL,
    AOCEChargingUnitInfo }

ChargingCase ::= ENUMERATED {
  chargingInformationAtCallSetup (0),
  chargingDuringACall (1),
  chargingAtTheEndOfACall (2) }

AOCSCurrencyInfoList ::= SEQUENCE SIZE (1..10) OF AOCSCurrencyInfo

AOCSCurrencyInfo ::= SEQUENCE {
  chargedItem ChargedItem,
  CHOICE {
    specificCurrency CHOICE {
      durationCurrency [1] DurationCurrency,
      flatRateCurrency [2] FlatRateCurrency,
      volumeRateCurrency [3] VolumeRateCurrency},
    specialChargingCode SpecialChargingCode,
  }
}

```

	freeOfCharge	[4] NULL,
	currencyInfoNotAvailable	[5] NULL} }
AOCSSpecialArrInfo	::= INTEGER (1..10)	
ChargedItem	::= ENUMERATED {	
	basicCommunication	(0),
	callAttempt	(1),
	callSetup	(2),
	userToUserInfo	(3),
	operationOfSupplementaryServ	(4) }
DurationCurrency	::= SEQUENCE {	
	dCurrency	[1] Currency,
	dAmount	[2] Amount,
	dChargingType	[3] ChargingType,
	dTime	[4] Time,
	dGranularity	[5] Time OPTIONAL }
FlatRateCurrency	::= SEQUENCE {	
	fRCurrency	[1] Currency,
	fRAmount	[2] Amount }
VolumeRateCurrency	::= SEQUENCE {	
	vRCurrency	[1] Currency,
	vRAmount	[2] Amount,
	vRVolumeUnit	[3] VolumeUnit}
SpecialChargingCode	::= INTEGER (1..10)	
AOCDCurrencyInfo	::= CHOICE {	
	specificCurrency	SEQUENCE {
	recordedCurrency	[1] RecordedCurrency,
	typeOfChargingInfo	[2] TypeOfChargingInfo,
	aOCDBillingId	[3] AOCDBillingId OPTIONAL },
	freeOfCharge	[1] NULL}
AOCDCargingUnitInfo	::= CHOICE {	
	specificChargingUnits	SEQUENCE {
	recordedUnitsList	[1] RecordedUnitsList,
	typeOfChargingInfo	[2] TypeOfChargingInfo,
	aOCDBillingId	[3] AOCDBillingId OPTIONAL },
	freeOfCharge	[1] NULL}
RecordedCurrency	::= SEQUENCE {	
	rCurrency	[1] Currency,
	rAmount	[2] Amount }
RecordedUnitsList	::= SEQUENCE SIZE (1..32) OF RecordedUnits	
TypeOfChargingInfo	::= ENUMERATED {	
	subTotal	(0),
	total	(1)}
RecordedUnits	::= SEQUENCE {	
	CHOICE{	
	recordedNumberOfUnits	NumberOfUnits,
	notAvailable	NULL},
	recordedTypeOfUnitsTypeOfUnit	OPTIONAL }
AOCDBillingId	::= ENUMERATED {	
	normalCharging	(0),
	reverseCharging	(1),

```

        creditCardCharging (2)}
AOCECurrencyInfo ::= SEQUENCE {
    CHOICE {
        specificCurrency SEQUENCE {
            recordedCurrency [1] RecordedCurrency,
            aOCEBillingId [2] AOCEBillingId OPTIONAL},
            freeOfCharge [1] NULL},
        chargingAssociationChargingAssociation OPTIONAL}
AOCEChargingUnitInfo ::= SEQUENCE {
    CHOICE {
        specificChargingUnits SEQUENCE {
            recordedUnitsList [1] RecordedUnitsList,
            aOCEBillingId [2] AOCEBillingId OPTIONAL},
            freeOfCharge [1] NULL},
        chargingAssociationChargingAssociation OPTIONAL}
AOCEBillingId ::= ENUMERATED {
    normalCharging (0),
    reverseCharging (1),
    creditCardCharging (2),
    callForwardingUnconditional (3),
    callForwardingBusy (4),
    callForwardingNoReply (5),
    callDeflection (6),
    callTransfer (7)}
Currency ::= IA5String (SIZE (1..10))
Amount ::= SEQUENCE {
    currencyAmount [1] CurrencyAmount,
    multiplier [2] Multiplier }
CurrencyAmount ::= INTEGER (0..16777215)
Multiplier ::= ENUMERATED {
    oneThousandth (0),
    oneHundredth (1),
    oneTenth (2),
    one (3),
    ten (4),
    hundred (5),
    thousand (6)}
Time ::= SEQUENCE {
    lengthOfTimeUnit [1] LengthOfTimeUnit,
    scale [2] Scale }
LengthOfTimeUnit ::= INTEGER (0..16777215)
Scale ::= ENUMERATED {
    oneHundredthSecond (0),
    oneTenthSecond (1),
    oneSecond (2),
    tenSeconds (3),
    oneMinute (4),
    oneHour (5),
    twentyFourHours (6)}
VolumeUnit ::= ENUMERATED {
    octet (0),
    segment (1),
    message (2) }
TypeOfUnit ::= INTEGER (1..16) -- Value 1-16
NumberOfUnits ::= INTEGER (0..16777215)
ChargingType ::= ENUMERATED {
    continuousCharging (0),
    stepFunction (1) }
ChargingAssociation ::= CHOICE {
    chargeNumber [0] EXPLICIT PartyNumber,
    chargeIdentifier ChargeIdentifier}
ChargeIdentifier ::= INTEGER (-32768..32767)

```

```

NoChargingInfoAvailable ::= ERROR

chargingRequest          ChargingRequest          ::= 30
aOCSCurrency            AOCSCurrency            ::= 31
aOCSSpecialArr          AOCSSpecialArr          ::= 32
aOCDCurrency            AOCDCurrency            ::= 33
aOCDChargingUnit        AOCDChargingUnit        ::= 34
aOCECurrency            AOCECurrency            ::= 35
aOCEChargingUnit        AOCEChargingUnit        ::= 36
noChargingInfoAvailable NoChargingInfoAvailable ::= 26

END

```

7 State definitions

The following states have been defined for the user:

AOC Request: the user has sent an AOC request to the network and is waiting for a response (note).

AOC Active: an AOC supplementary service has been activated by a user on a per call basis (note).

The following states have been defined for the network:

AOC Idle: an AOC supplementary service is not activated (note).

AOC-S Activated: the AOC-S supplementary service has been activated either on a per call basis or for all calls.

AOC-D Activated: the AOC-D supplementary service has been activated either on a per call basis or for all calls.

AOC-E Activated: the AOC-E supplementary service has been activated either on a per call basis or for all calls.

AOC-S Idle: the network has sent the AOC-S charging information to the served user. This is a "waiting" condition where either a change in the charging rate, or the suspension of the basic call occurs, or the call is cleared.

AOC-S Suspended: the AOC-S supplementary service is activated, and the served user has invoked the terminal portability supplementary service for this call.

AOC-D Suspended: the AOC-D supplementary service is activated, and the served user has invoked the terminal portability supplementary service for this call.

AOC-E Suspended: the AOC-E supplementary service is activated, and the served user has invoked the terminal portability supplementary service for this call.

NOTE: These states exist for each instance of the AOC supplementary service.

8 Signalling procedures at the coincident S and T reference point

8.1 Activation, deactivation and registration

8.1.1 Normal operation

These supplementary services may be activated on a per call basis or they may be active for all calls. The activation on a per-call basis is only active for the lifetime of that call.

If an AOC supplementary service is subscribed to for all calls, no signalling procedure is defined for the activation of the service. The network shall automatically activate the subscribed AOC supplementary service at each call setup.

To activate an AOC supplementary service, the user shall include in the SETUP message a Facility information element containing a ChargingRequest invoke component. The ChargingRequest invoke component shall indicate the AOC supplementary service to be activated. Each AOC supplementary service is activated independently and one, two, or three activations can thus occur in the same SETUP message.

If the network activates the requested AOC supplementary service (e.g. the served user is allowed to request the information), the network shall acknowledge the request by returning a ChargingRequest return result component within a Facility information element in a call control message (i.e. SETUP ACKNOWLEDGE, CALL PROCEEDING, PROGRESS, ALERTING, or CONNECT message - whichever is appropriate). Alternatively, the network can use a FACILITY message to convey the ChargingRequest return result component if a call control message is not available when the information is to be sent.

If a user has requested the AOC-S supplementary service and the activation request is accepted by the network, the procedure of subclause 8.2.1.1 shall be followed.

If a user has requested the AOC-D or AOC-E supplementary services and the activation request is accepted by the network, the network shall send a ChargingRequest return result component to the user indicating "chargingInfoFollows".

If the user receives a correctly encoded ChargingRequest return result component, the user shall accept the provided information and shall not respond to the network.

No signalling procedure is defined for the registration of an AOC supplementary service.

8.1.2 Exceptional procedures

The following exceptional procedures shall apply:

- a) if the AOC supplementary service is activated for all calls and the network cannot provide the charging information, the network shall, at the time it determines that the information is not available, send a Facility information element including an AOCSCurrency, AOCSSpecialArr, AOCDCurrency, AOCDChargingUnit, AOCECurrency or AOCEChargingUnit invoke component indicating "chargeNotAvailable" to the user and continue normal call handling;
- b) if the user receives a correctly encoded AOCSCurrency, AOCSSpecialArr, AOCDCurrency, AOCDChargingUnit, AOCECurrency or AOCEChargingUnit invoke component, the user shall accept the provided information and shall not respond to the network;
- c) if the AOC supplementary service is requested on a per-call basis and the network cannot provide the charging information, the network shall include the Facility information element containing a ChargingRequest return error component in a call control or FACILITY message and continue the basic call. The ChargingRequest return error component shall indicate either:
 - 1) one of the errors from the General-Errors list; or
 - 2) "NoChargingInfoAvailable", whichever is appropriate.

The "NoChargingInfoAvailable" value indicates that the served user would normally receive charging information but that in this case the information cannot be sent to the served user;
- d) if the network receives a request for any of the AOC supplementary services in any other message than a SETUP message, and item c) does not apply, then the network shall send a ChargingRequest return error component indicating "invalidCallState" to the user;
- e) if a user receives a ChargingRequest return error component from the network, the user shall not take any further protocol action. However, the user shall continue normal call handling;
- f) if a user or the network receives a reject component, no protocol actions shall be taken;
- g) if the user receives no response to the ChargingRequest invoke component and subsequently receives an AOCSCurrency, AOCSSpecialArr, AOCDCurrency, AOCDChargingUnit, AOCECurrency or AOCEChargingUnit invoke component, the user shall ignore this component;

- h) if the user receives a ChargingRequest return error component or a reject component as a response to a ChargingRequest invoke component and subsequently receives an AOCSCurrency, AOCSSpecialArr, AOCDCurrency, AOCDChargingUnit, AOCECurrency or AOCEChargingUnit invoke component, the user shall accept the information provided and shall not respond to the network;
- i) if a user requests on a per call basis an AOC supplementary service which is activated for all calls, the network shall acknowledge the request as specified in subclause 8.1.1. However, the network shall only send charging information as a result of one activation of each AOC supplementary service activated.

8.2 Invocation and operation

In the following subclauses the procedures for the transfer of charging information are given.

The transfer of charging information may occur:

- during the call establishment phase (AOC-S supplementary service);
- in the Active state of a call (AOC-S and AOC-D supplementary services);
- during the call clearing phase (AOC-S, AOC-D, and AOC-E supplementary services); or
- independent of a bearer at the user-network interface (AOC-E supplementary service).

NOTE: The transfer of charging information in an invoke component is done according to the operation class 5. Operation class 5 implies that neither a return result component nor a return error component will be received as an answer to an invoke component. A consequence of using this operation class is that the sending of information in an invoke component is not a confirmed service.

8.2.1 Transfer of charging information in the call establishment phase

8.2.1.1 Normal operation

For the AOC-S supplementary service, the activation and invocation of the supplementary service is performed simultaneously - i.e. the activation works as both an activation and an invocation of the supplementary service.

For the AOC-S supplementary service, the network shall give charging information either in currency units or as a special charging arrangement.

NOTE: The parameters described for the AOC-S supplementary service to express the duration rate provides a solution both for continuous charging as well as for charging with the step function method. It is up to the network to specify the value of the parameters in a manner that it will fit with the continuous charging method or with the step function method.

If sending AOC-S supplementary service information to the served user, the network shall include charging rate information related only to the particular service(s) requested by the user at call setup.

When the network sends charging information to the served user in the call establishment phase, the network shall include the Facility information element in a call control message which is sent to the user (i.e. SETUP ACKNOWLEDGE, CALL PROCEEDING, PROGRESS, ALERTING, or CONNECT message - whichever is appropriate). Alternatively, the network can use a FACILITY message to send charging information to the user, if a call control message is not available when the information is to be sent.

The Facility information element shall contain information about the charging rate applicable to that call. If the AOC-S supplementary service is activated on a per call basis, the Facility information element shall contain the chargingRequest return result component. If the AOC-S supplementary service is activated for all calls, the Facility information element shall contain an AOCSCurrency invoke component or an AOCSSpecialArr invoke component. This charging information shall consist of one of the following types:

- AOCSCurrencyInfoList; or
- AOCSSpecialArrInfo.

If the user receives a correctly encoded ChargingRequest return result component, the user shall accept the provided information and shall not respond to the network.

If the user receives a correctly encoded AOCSCurrency or AOCSSpecialArr invoke component, the user shall accept the provided information and shall not respond to the network.

8.2.1.2 Exceptional procedures

In the case that charging information is not available in the network, the network shall inform the served user and the call shall be allowed to continue according to normal call handling procedures.

If the AOC-S supplementary service has been activated on a per call basis and if charging information is not available within the call establishment time, the network shall include a Facility information element within an appropriate message sent to the user. The Facility information element shall contain the ChargingRequest return error component indicating "NoChargingInfoAvailable".

If the user receives a correctly encoded ChargingRequest return error component, the user shall accept the reason for error and shall not respond to the network.

If the AOC-S supplementary service is activated for all calls and if charging information is not available within the call establishment time, the network shall include a Facility information element within an appropriate message sent to the user. The Facility information element shall contain the invoke component indicating "chargeNotAvailable".

If the user receives a correctly encoded AOCSCurrency or AOCSSpecialArr invoke component, the user shall accept the provided information and shall not respond to the network.

If the network receives a reject component from the user, the network shall take no further protocol actions. Normal call handling shall continue.

8.2.2 Transfer of charging information in the Active state

8.2.2.1 Normal operation

If the AOC-D supplementary service is offered, the originating network shall send charging information during a call. The rate of sending messages may vary from call to call and during a call.

If the AOC-S supplementary service is offered and if there is a subsequent change in the charging rate, the network shall indicate to the user when the change in the charging rate has occurred (e.g. the user has invoked a supplementary service during the Active state and this has an impact on the cost of the call, the changed charging rate information can only be given at the time the supplementary service is invoked).

When the network transfers charging information to the served user during the Active state, the network shall include the Facility information element in the FACILITY message sent to the user. The Facility information element shall contain one of the following types of charging information in an invoke component:

- a) charging rate, if a change in the charging rates has occurred and the AOC-S supplementary service has been activated; or
- b) cumulative charging information related to the AOC-D supplementary service. The network shall set TypeOfChargingInfo = "subTotal (0)".

In case a), the network shall send one of the following types of charging information to the served user:

- AOCSCurrencyInfoList in an AOCSCurrency invoke component; or
- AOCSSpecialArrInfo in an AOCSSpecialArr invoke component.

For the AOC-S supplementary service, the network shall give charging information either in currency units or as a special charging arrangement.

NOTE: The parameters described for the AOC-S supplementary service to express the duration rate provides a solution both for continuous charging as well as for charging with the step function method. It is up to the network to specify the value of the parameters in a manner that it will fit with the continuous charging method or with the step function method.

In case b), the network shall send one of the following types of charging information to the served user:

- AOCDCurrencyInfo in an AOCDCurrency invoke component; or
- AOCDChargingUnitInfo in an AOCDChargingUnit invoke component.

If the AOC-D supplementary service is provided, the network shall give charging information, as a network option, either based on currency units or on charging units. Only the charged items that affect the charging applied to that call shall be covered.

If the user receives a correctly encoded AOCSCurrency, AOCSSpecialArr, AOCDCurrency or AOCDChargingUnit invoke component, the user shall accept the provided information and shall not respond to the network.

8.2.2.2 Exceptional procedures

In the case that charging information is temporarily not available in the network, the network shall continue normal call handling and no indication shall be sent to the user. This applies to the cases where the AOC-S or AOC-D supplementary services are activated.

If the network receives a reject component from the user, the network shall take no further protocol actions. Normal call handling shall continue.

8.2.3 Transfer of charging information in the call clearing phase

8.2.3.1 Normal operation

When the network transfers charging information to the served user in the call clearing phase, the network shall include the Facility information element either in the DISCONNECT or the RELEASE message, depending on who initiates the call clearing. If the served user initiates call clearing by sending a DISCONNECT message to the network, the network shall include the charging information in the RELEASE message sent from the network to the served user. If the remote user or the network initiates call clearing, the network shall include the charging information in the DISCONNECT message sent from the network to the served user.

In both these cases, if the AOC-S or AOC-D or the AOC-E supplementary services are activated, the network shall include the charging information in an invoke or return result component within the Facility information element as follows:

- If the AOC-S supplementary service on a per call basis has been requested by the served user, and the network has not yet responded to this activation request when the call is cleared prematurely (i.e. before the Active call state is reached), then the network shall include a ChargingRequest return result component in the first clearing message returned to the served user. Alternatively, the network may use a FACILITY message to convey the ChargingRequest return result component before sending the appropriate clearing message.
- If the AOC-S supplementary service is activated for all calls, the network may send one of the following types of charging information when the call is cleared prematurely and no charging information has been sent yet:
 - AOCSCurrencyInfoList in an AOCSCurrency invoke component; or
 - AOCSSpecialArrInfo in an AOCSSpecialArr invoke component.

For the AOC-S supplementary service, the network shall give charging information either in currency units or as a special charging arrangement.

NOTE: The parameters described for the AOC-S supplementary service to express the duration rate provides a solution both for continuous charging as well as for charging with the step function method. It is up to the network to specify the value of the parameters in a manner that it will fit with the continuous charging method or with the step function method.

- If the AOC-D supplementary service is activated, the network shall send one of the following types of charging information:
 - AOCDCurrencyInfo in an AOCDCurrency invoke component; or
 - AOCDChargingUnitInfo in an AOCDChargingUnit invoke component;

- In addition, for the AOC-D supplementary service the network shall set the TypeOfChargingInfo = "total (1)".
- If the AOC-E supplementary service is activated, the network shall send one of the following types of charging information:
 - AOCECurrencyInfo in an AOCECurrency invoke component; or
 - AOCEChargingUnitInfo in an AOCEChargingUnit invoke component.

If the AOC-D or AOC-E supplementary services are provided, the network shall give charging information, as a network option, either based on currency units or on charging units. Only the charged items that affects the charging applied to that call shall be covered.

If the user receives a correctly encoded AOCSCurrency, AOCSSpecialArr, AOCDCurrency, AOCDChargingUnit, AOCECurrency or AOCEChargingUnit invoke component or ChargingRequest return result component, the user shall accept the provided information and shall not respond to the network.

In the case that the served user does not respond to a DISCONNECT message sent from the network, the network shall include the charging information, previously sent in the DISCONNECT message, in the subsequent RELEASE message(s) sent to the served user.

In the case that the served user does not respond to a RELEASE message sent from the network, the network shall include the charging information contained in the first RELEASE message in the retransmitted RELEASE message.

In the case that the network receives a RELEASE message as the first clearing message from the served user, the network shall send an invoke or return result component containing charging information to the served user in the Facility information element within the RELEASE COMPLETE message.

8.2.3.2 Exceptional procedures

In the case that charging information is not available in the network, the network shall inform the served user and continue normal call handling procedures.

If an AOC supplementary service has been activated and:

- a) if charging information is not available to be sent to the served user and the network provides charging information based on currency units, then the network shall include the Facility information element in an appropriate message containing an invoke component indicating "chargeNotAvailable" or a ChargingRequest return error component indicating the error "NoChargingInfoAvailable";
- b) if charging information is available but not complete and the network provides charging information based on currency units or only one type of charging unit, then the network shall include an invoke component or ChargingRequest return error component in the Facility information element in a clearing message sent from the network to the served user. The invoke component shall indicate "chargeNotAvailable". The ChargingRequest return error component shall indicate error "NoChargingInfoAvailable";
- c) if charging information is not available to be sent to the served user and only one type of charging unit is used, then the network shall include the Facility information element in an appropriate message containing an invoke component indicating "chargeNotAvailable"; or
- d) if more than one type of charging unit is used in the network and charging information related to all charging unit types is not available when charging information is to be sent to the served user, then the network shall send the available charging information and indicate "notAvailable" for the remaining charging unit types. This applies to both AOCDChargingUnitInfo and AOCEChargingUnitInfo.

If the call fails and the network knows that charges have been applied to the call, the recorded charges shall be transferred to the user. An invoke component contained in the Facility information element shall indicate the relevant charging information which is transferred to the served user. If the AOC-D supplementary service is activated, the network shall send one of the following types of charging information:

- AOCDCurrencyInfo in an AOCDCurrency invoke component; or
- AOCDChargingUnitInfo in an AOCDChargingUnit invoke component.

If the AOC-E supplementary service is activated, the network shall send one of the following types of charging information:

- AOCECurrencyInfo in an AOCECurrency invoke component; or
- AOCEChargingUnitInfo in an AOCEChargingUnit invoke component.

If the user receives a correctly encoded AOCDCurrency, AOCDChargingUnit, AOCECurrency or AOCEChargingUnit invoke component, the user shall accept the provided information and shall not respond to the network.

If the network receives a reject component from the user, the network shall take no further protocol actions. Normal call handling shall continue.

8.2.4 Transfer of charging information independent of a bearer at the user-network interface

8.2.4.1 Normal operation

In some cases, the network shall transfer charging information to the served user, without a bearer being established at the user-network interface (e.g. in connection with the invocation of a Diversion supplementary service). This can occur only when the AOC-E supplementary service is activated. The network shall send the charging information to the served user when the call, incurring the charge, is released (e.g. the diverted call).

The network shall send the charging information in a FACILITY message containing in the Called party number information element the ISDN number used in the activation and/or invocation of the supplementary service for which charging information is to be sent. If the network has not received an ISDN number from the user, then the network shall not include the Called party number information element in the FACILITY message when the charging information is sent.

The network shall send the FACILITY message using the dummy call reference, as specified in clause 8 of EN 300 196-1 [11]. If the network knows that a point-to-multipoint configuration exists at the served user's access, the network shall send the FACILITY message using the broadcast datalink (as specified in subclause 8.3.2.4 of EN 300 196-1 [11]). Otherwise the network shall send the FACILITY message using the already established datalink (as specified in subclause 8.3.2.2 of EN 300 196-1 [11]).

The FACILITY message shall contain the Facility information element and indicate in the "AOCEBillingId" of the invoke component why this charge is incurred (e.g. a call has been diverted and the served user is paying for some part of the diverted call). The "AOCEBillingId" is transferred in one of the following types of charging information:

- AOCECurrencyInfo in an AOCECurrency invoke component; or
- AOCEChargingUnitInfo in an AOCEChargingUnit invoke component.

If the user receives a correctly encoded AOCECurrency or AOCEChargingUnit invoke component, the user shall accept the provided information and shall not respond to the network.

If the AOC-E supplementary service is provided, the network shall give charging information, as a network option, either based on currency units or on charging units. Only the charged items that affect the charging applied to that call shall be covered.

In order to identify that the charging information is associated with a particular call, an optional chargingAssociation parameter can be included in the charging information which is sent to the served user when such a call is cleared. The procedures for generating and using the "chargingAssociation" parameter shall be as defined in EN 300 195-1 [12].

8.2.4.2 Exceptional procedures

If an AOC supplementary service has been activated and:

- a) if charging information is not available to be sent to the served user and the network provides charging information based on currency units, then the network shall send an invoke component indicating "chargeNotAvailable" in a Facility information element within a FACILITY message to the served user;
- b) if charging information is available but not complete and the network provides charging information based on currency units or only one type of charging unit, then the network shall include an invoke component in the Facility information element within a FACILITY message sent from the network to the served user. The invoke component shall indicate "chargeNotAvailable";
- c) if charging information is not available to be sent to the served user and only one type of charging unit is used, then the network shall send a Facility information element containing an invoke component indicating "chargeNotAvailable" within a FACILITY message to the served user; or
- d) if more than one type of charging unit is used in the network and charging information related to all charging unit types is not available when charging information is to be sent to the served user, then the network shall send the available charging information and indicate "notAvailable" for the remaining charging unit types in a FACILITY message.

If provided, the FACILITY message shall contain in the Called party number information element the ISDN number used in the activation and/or invocation of the supplementary service for which charging information is to be sent. If the network has not received an ISDN number from the user, then the network shall not include the Called party number information element in the FACILITY message when the charging information is sent.

The network shall send the FACILITY message using the dummy call reference, as specified in clause 8 of EN 300 196-1 [11]. If the network knows that a point-to-multipoint configuration exists at the served user's access, the network shall send the FACILITY message using the broadcast datalink (as specified in subclause 8.3.2.4 of EN 300 196-1 [11]). Otherwise the network shall send the FACILITY message using the already established datalink (as specified in subclause 8.3.2.2 of EN 300 196-1 [11]).

In order to identify that the charging information is associated with a particular call, an optional ChargingAssociation parameter can be included in the charging information which is sent to the served user when such a call is cleared. The procedures for generating and using the "chargingAssociation" parameter shall be as defined in EN 300 195-1 [12].

If the network receives a reject component from the user, the network shall take no further protocol actions. Normal call handling shall continue.

9 Procedures for interworking with private ISDNs

The same procedures apply as for the coincident S and T reference point, as specified in clause 9.

10 Interactions with other networks

Not applicable.

11 Interactions with other supplementary services

The interaction of any of the AOC supplementary services with other supplementary services shall be as specified in EN 300 195-1 [12].

12 Parameter values (timers)

No specific timers are required.

13 Dynamic description (SDL diagrams)

The dynamic descriptions are specified in figures 1 to 9, according to ITU-T Recommendation Z.100 [13]. Figures 1 and 2 show the user side of the AOC supplementary service. Figures 3 to 9 show the network side.

In figure 3, one instance of the described process shall exist for each AOC supplementary service requested. These instances of the described process shall operate independently of each other. Each request for an AOC supplementary service shall be handled by a separate process and multiple requests for AOC supplementary services can be included in a SETUP message.

The following abbreviations are used in the SDL diagrams:

- Key:**
- AOC-S invoke = AOCSSpecialArr or AOCSCurrency invoke component;
 - AOC-D invoke = AOCDCurrency or AOCDChargingUnit invoke component;
 - AOC-E invoke = AOCECurrency or AOCEChargingUnit invoke component.

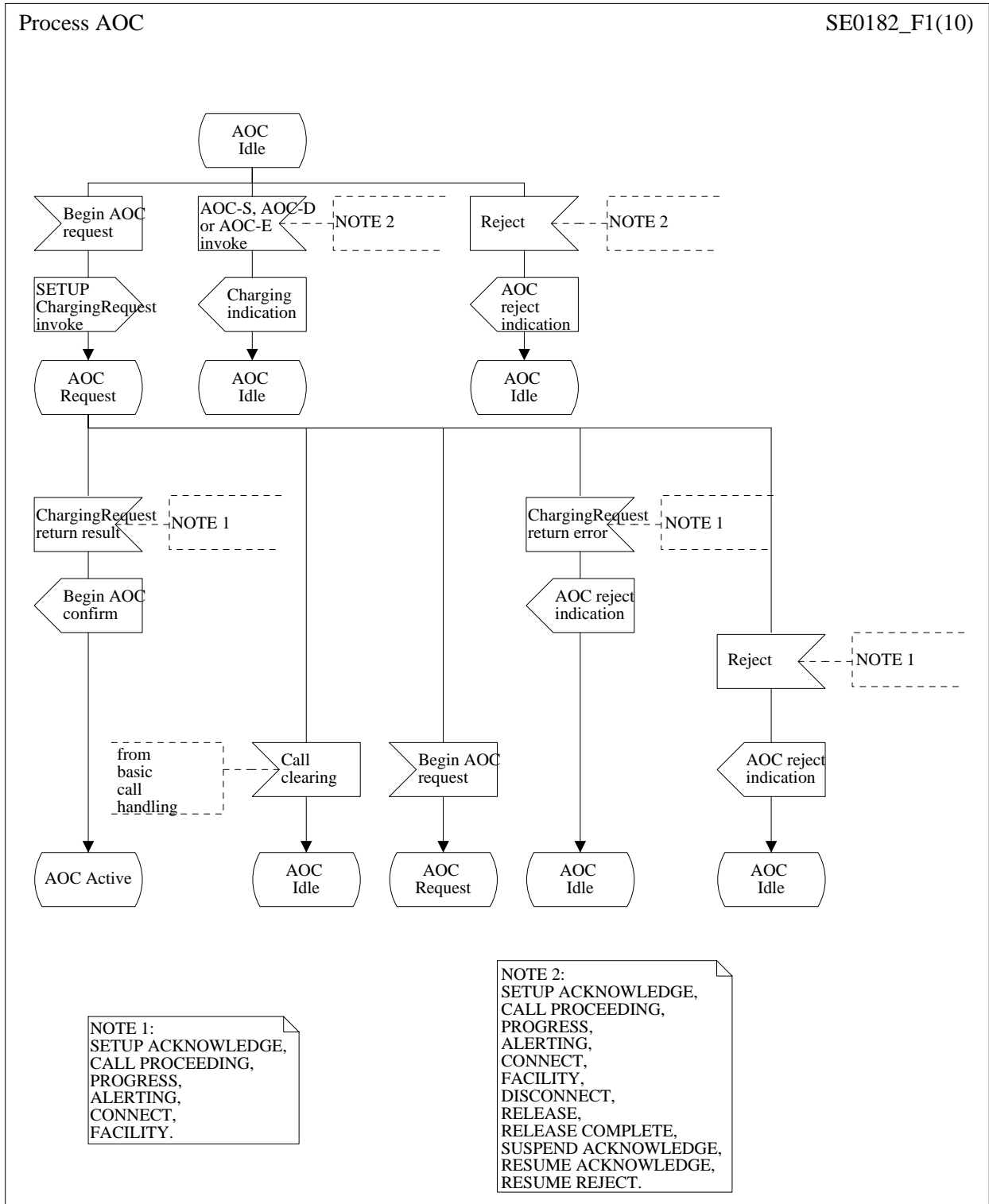

Figure 1: User side - AOC Idle

Process AOC

SE0182_F2(10)

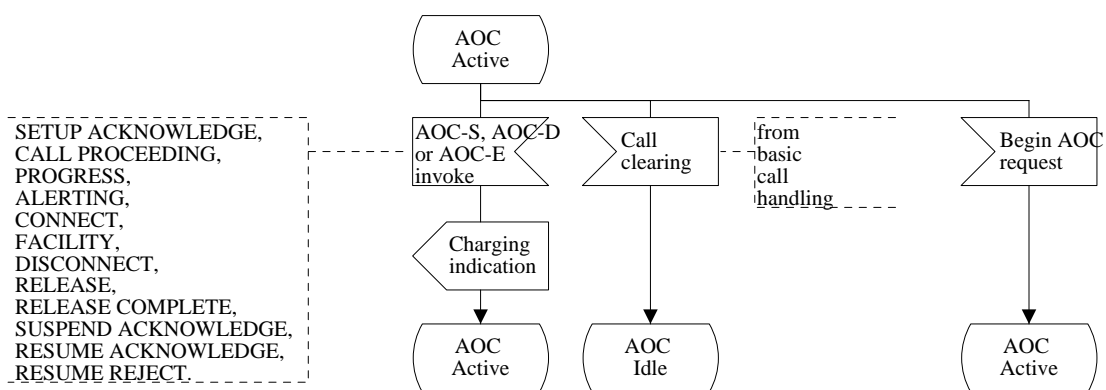

Figure 2: User side - AOC Active

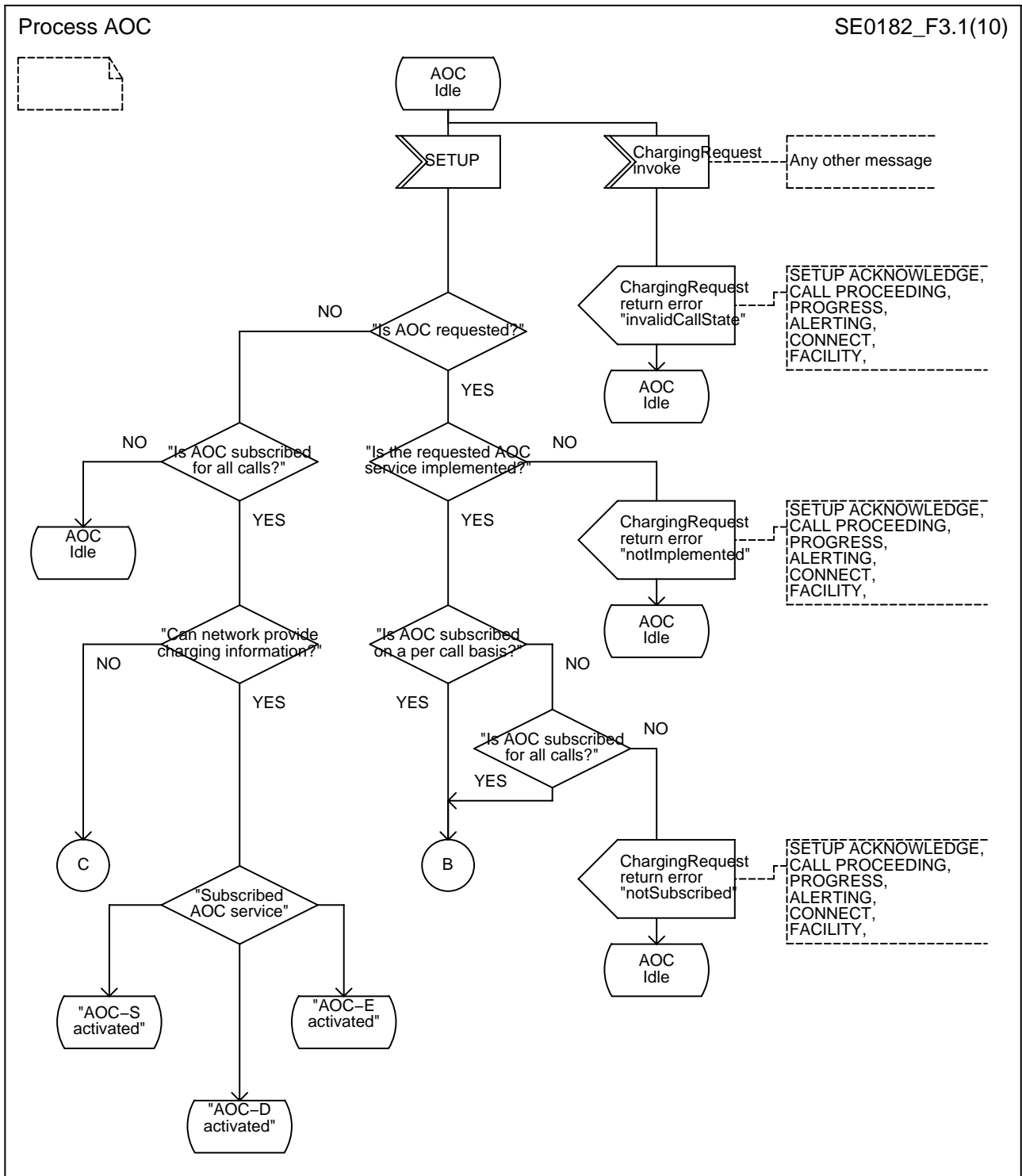

Figure 3 (sheet 1 of 2): Network side - AOC Idle

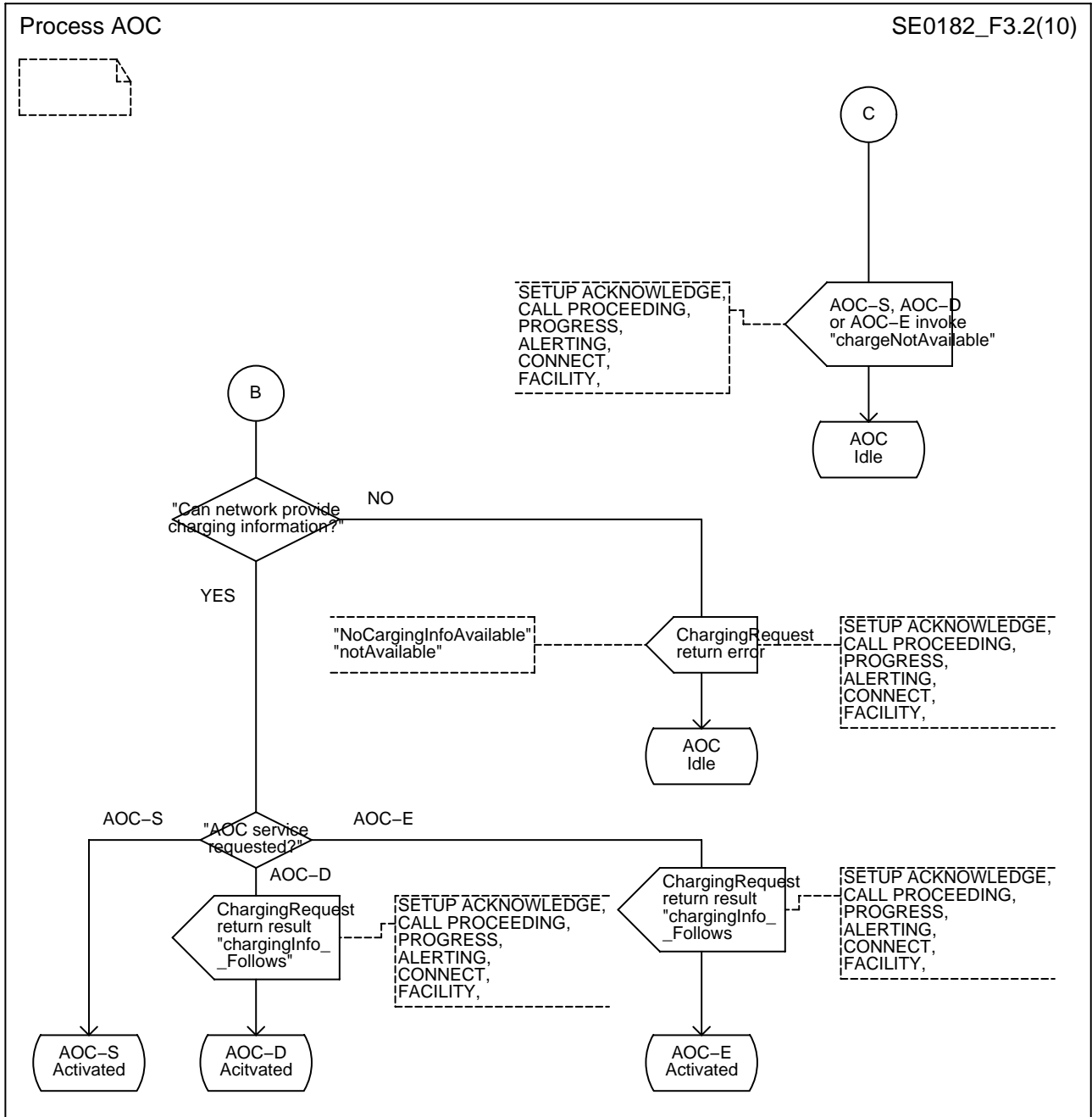
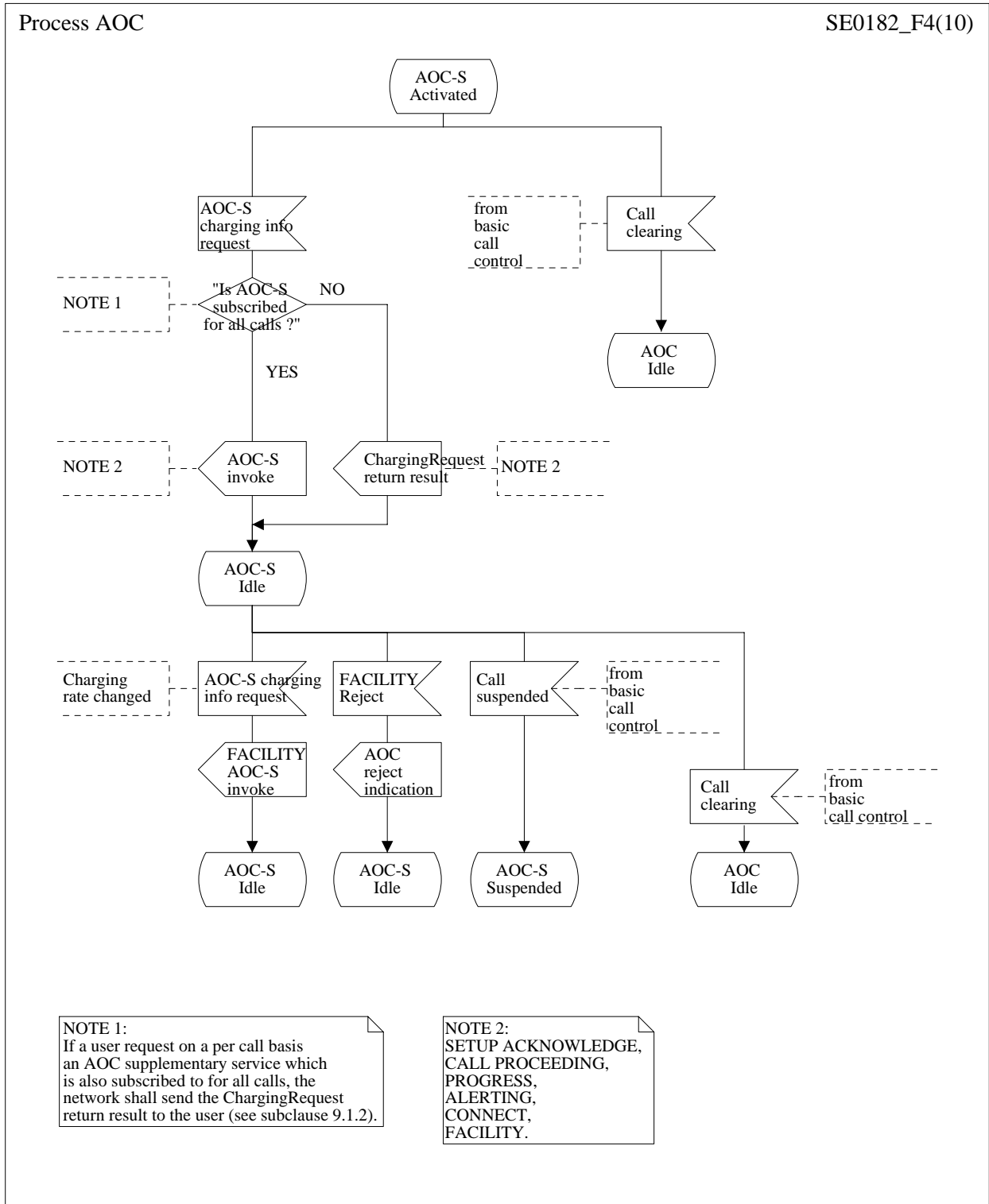

Figure 3 (sheet 2 of 2): Network side - AOC Idle



NOTE: The upper right input symbol "call clearing" should be fed as input into decision symbol "is AOC-S subscribed for all calls". Messages DISCONNECT, RELEASE and RELEASE COMPLETE must be added under note 3 with reference to subclause 8.2.3.

Figure 4: Network side - AOC-S Activated

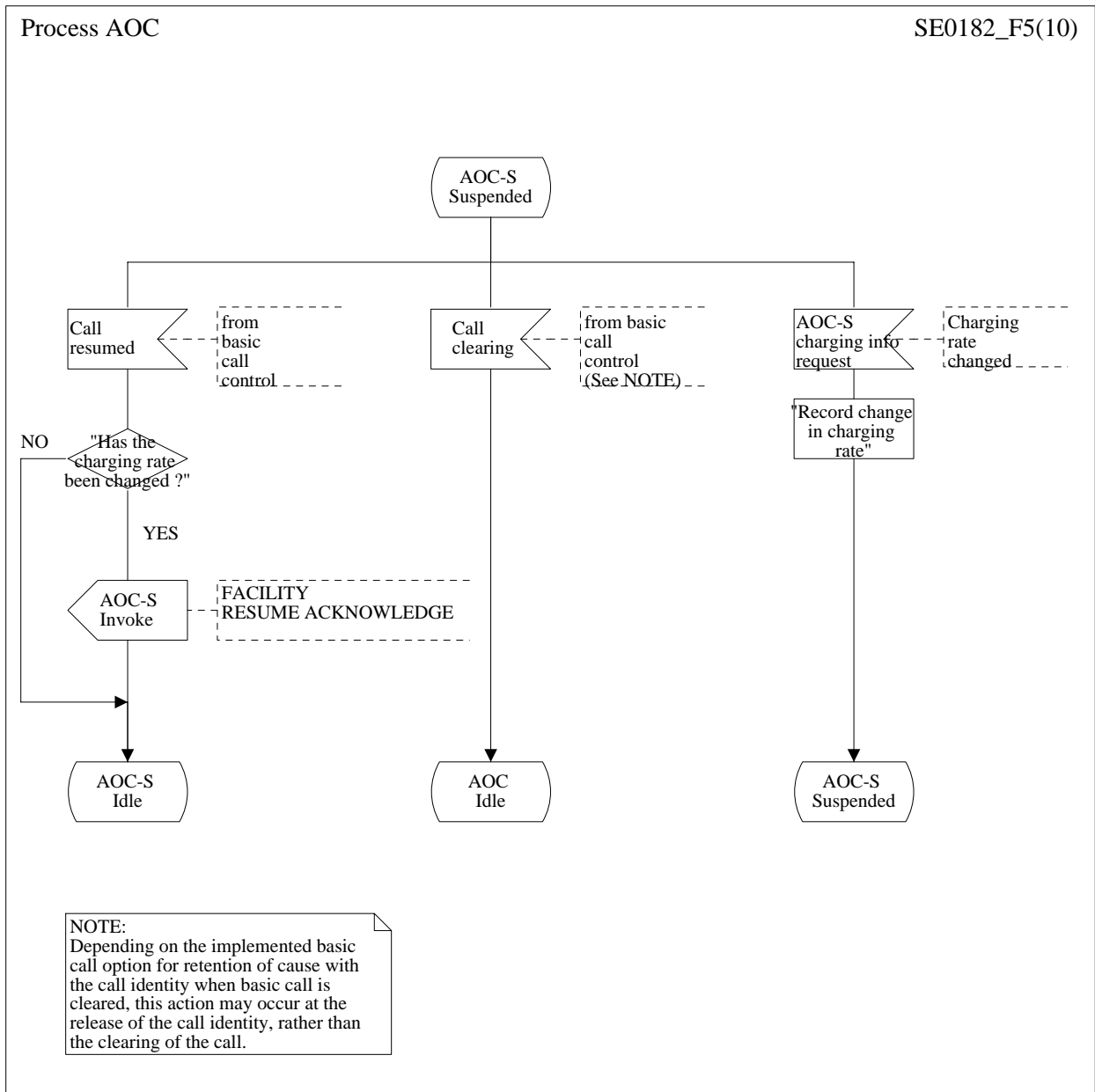

Figure 5: Network side - AOC-S Suspended

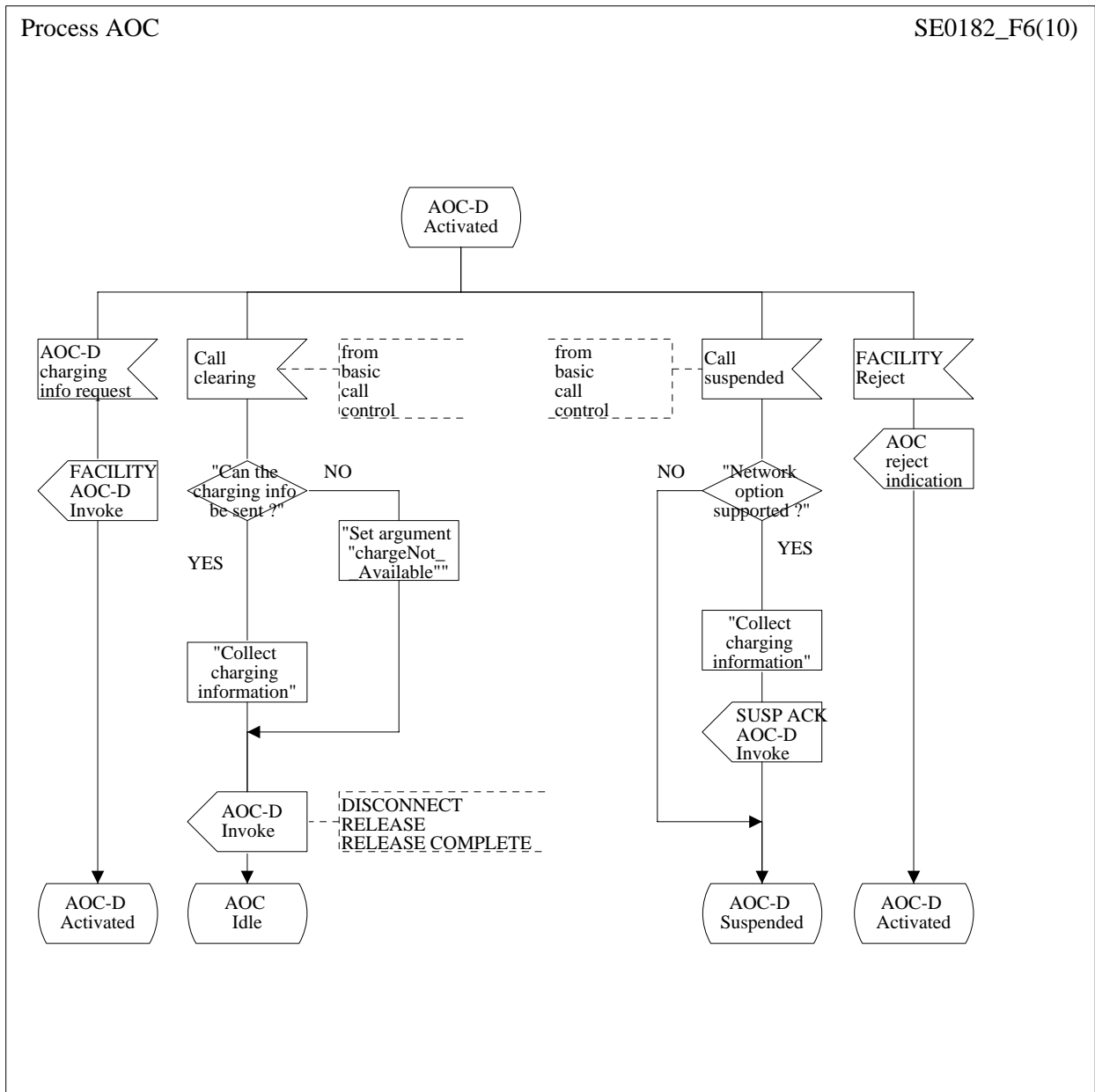

Figure 6: Network side - AOC-D Activated

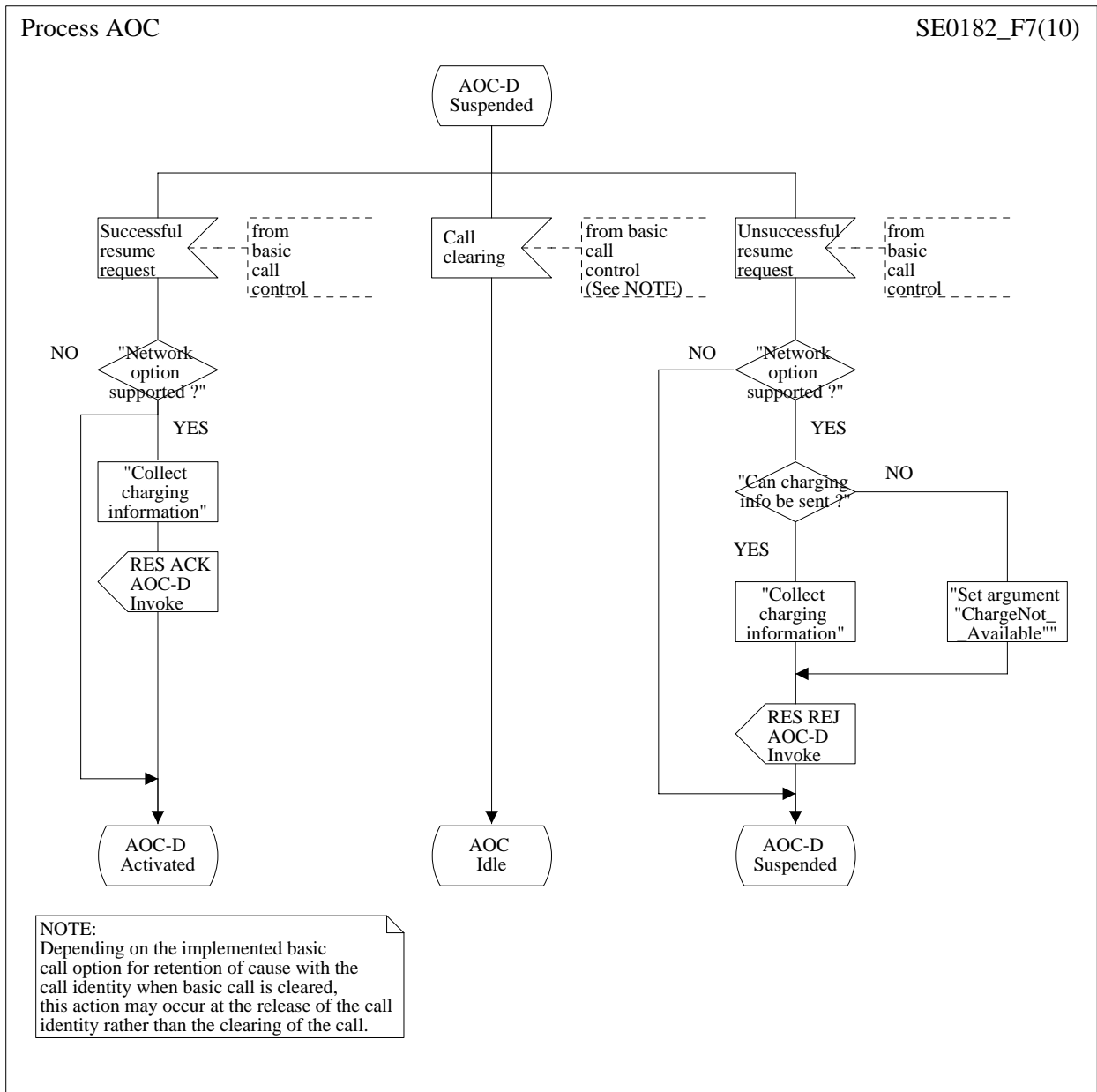

Figure 7: Network side - AOC-D Suspended

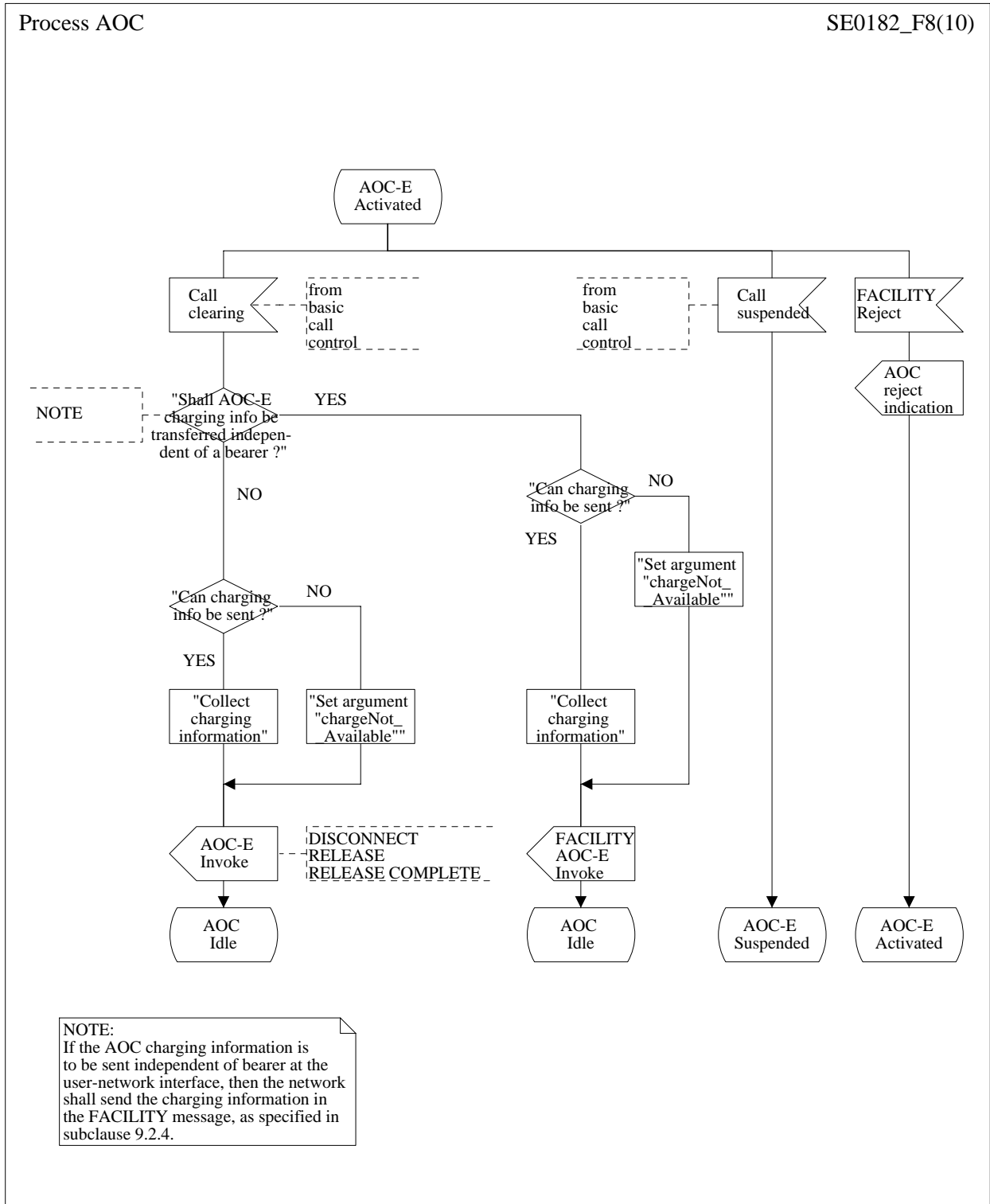

Figure 8: Network side - AOC-E Activated

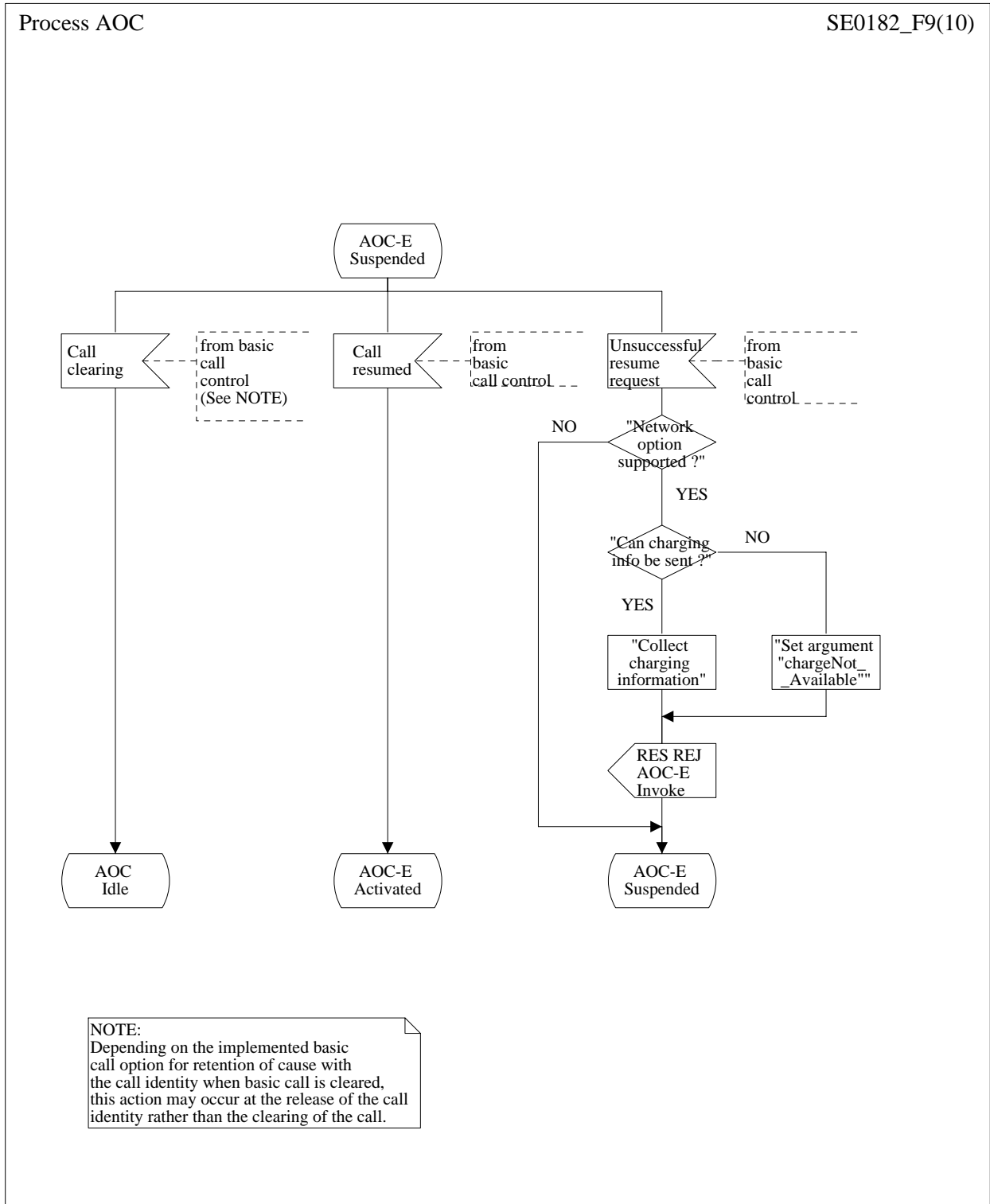

Figure 9: Network side - AOC-E Suspended

Annex A (informative): Signalling flows

In the following signalling flows it is assumed that the network has knowledge about the charging rate or the charges applied to a particular call. This does not exclude the possibility for the network to collect this information from another point in the network. The signalling flows across the user-network interface are the same for both cases.

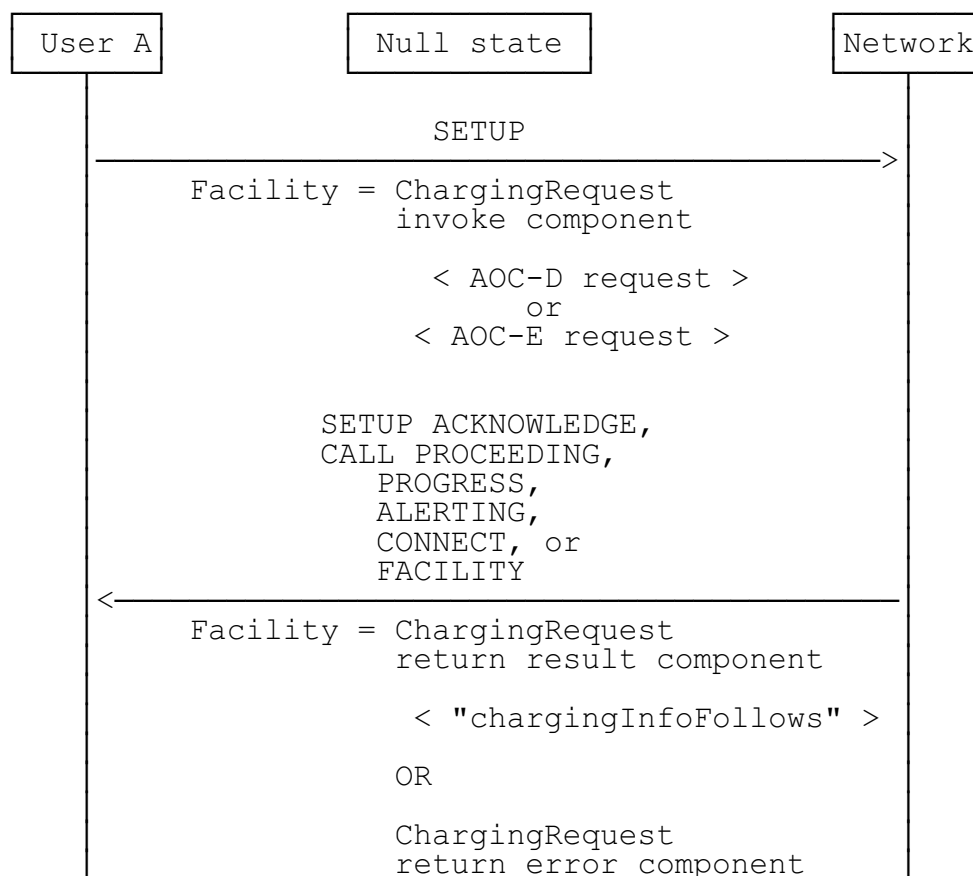

Figure A.1: AOC-D or AOC-E request procedure during call establishment

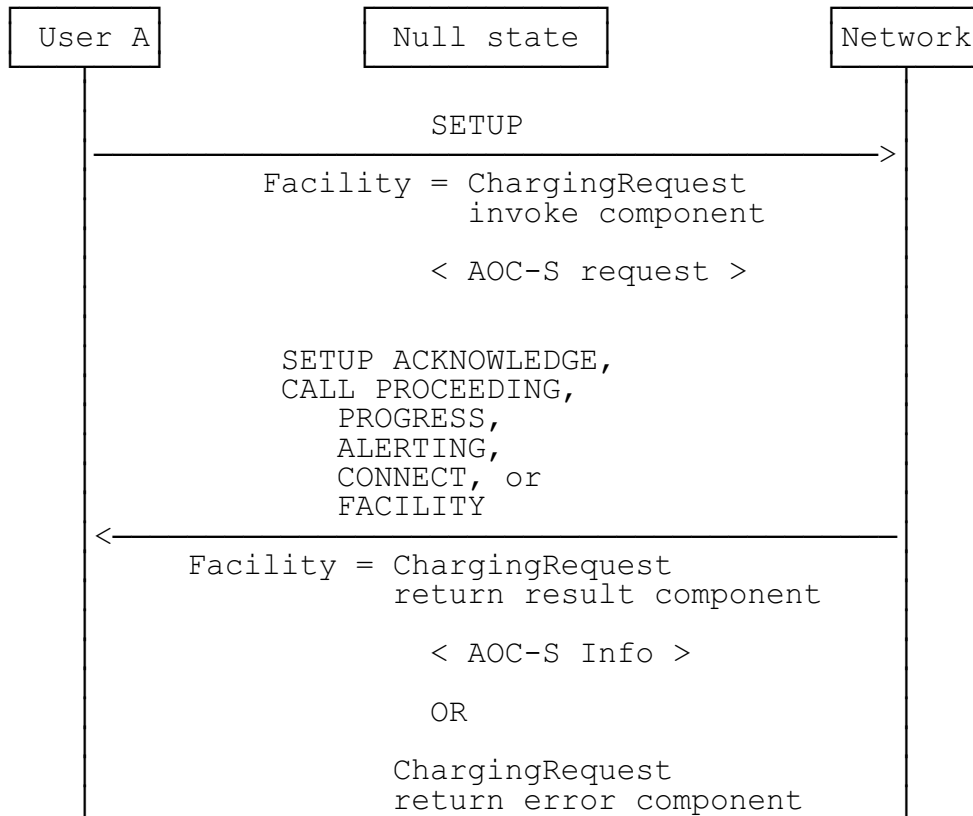

Figure A.2: Information about charging rates during call establishment, AOC-S activated on a per call basis

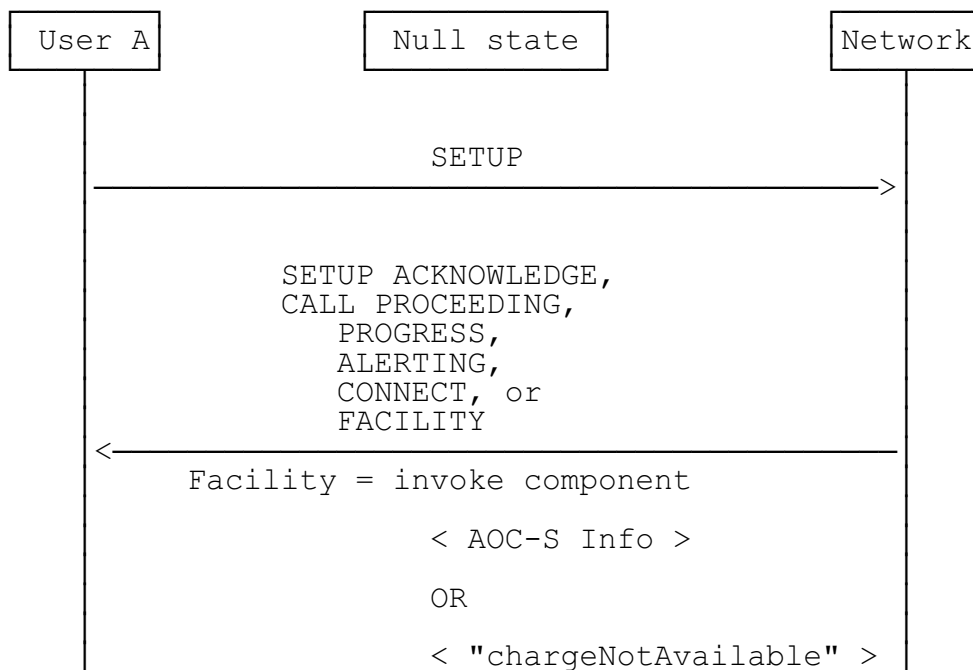
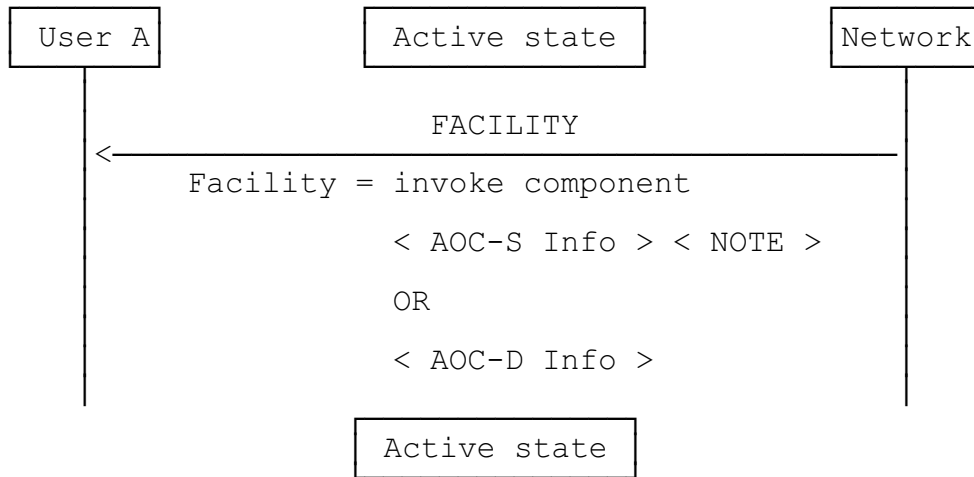

Figure A.3: Information about charging rates during call establishment, AOC-S activated for all calls



NOTE: Only sent if a change in the charging rate has occurred.

Figure A.4: Transfer of charging information during the Active state of a call

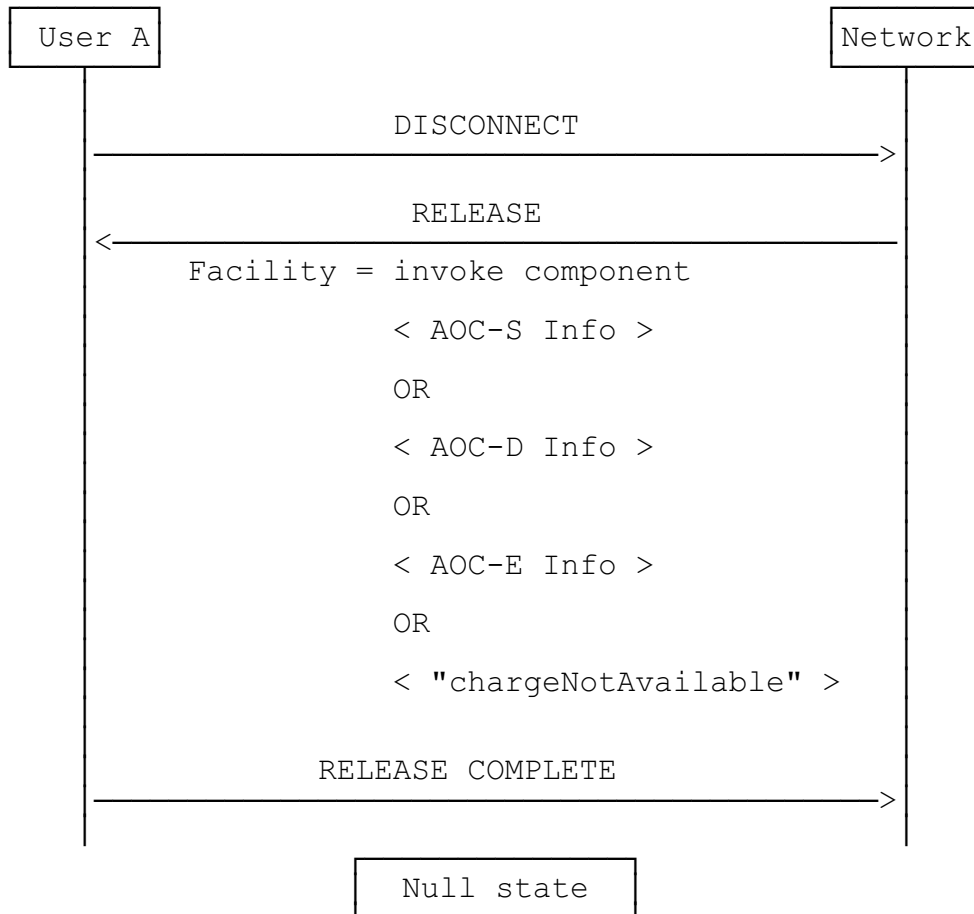

Figure A.5: Transfer of charging information during the call clearing phase, clearing initiated by the calling user

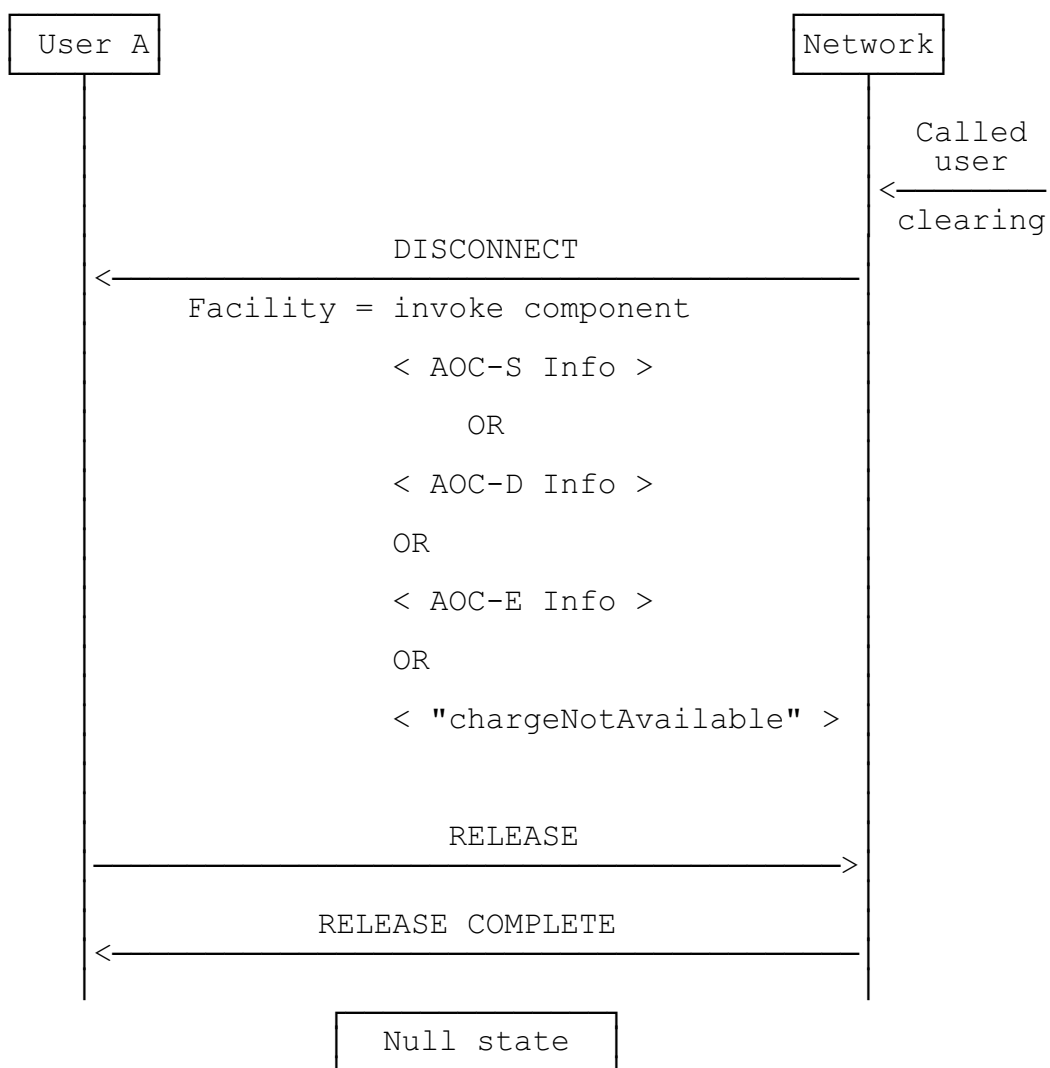

Figure A.6: Transfer of charging information during the call clearing phase, clearing initiated by the called user

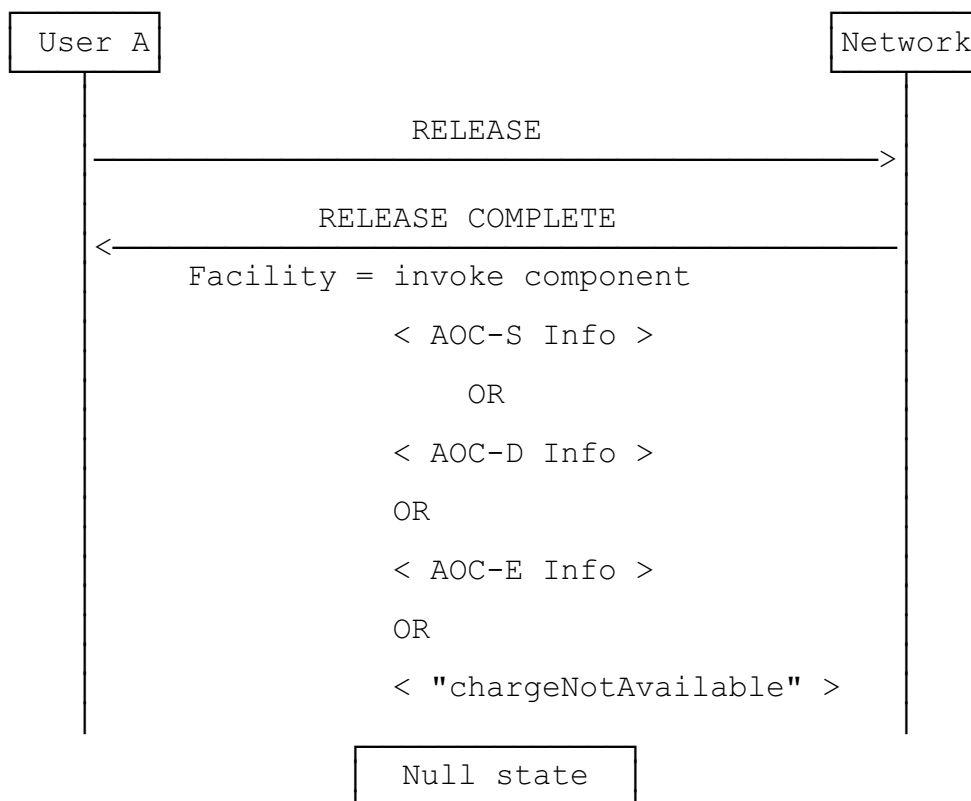

Figure A.7: Transferring charging information in the case the network receives a RELEASE message as the first message in the release procedure

Annex B (informative): Changes with respect to the previous version of EN 300 182-1 (V1.2.4)

The following changes have been done:

- Clarification of the procedures for transfer of charging information in the call clearing phase (subclause 8.2.3).
- Correction of an error in the SDL's (Figure 3).

History

Document history		
Edition 1	April 1993	Publication as ETS 300 182-1
V1.2.4	June 1998	Publication
V1.3.3	January 1999	Public Enquiry PE 9918: 1999-01-01 to 1999-04-30
V1.3.5	July 1999	Vote V 9938: 1999-07-05 to 1999-09-03
V1.3.6	September 1999	Publication